



晏杰光电
MAJOR LIGHTING

MJ-F2835L160WX-X-HE

SPECIFICATION SHEET

2019.04 V-1.0

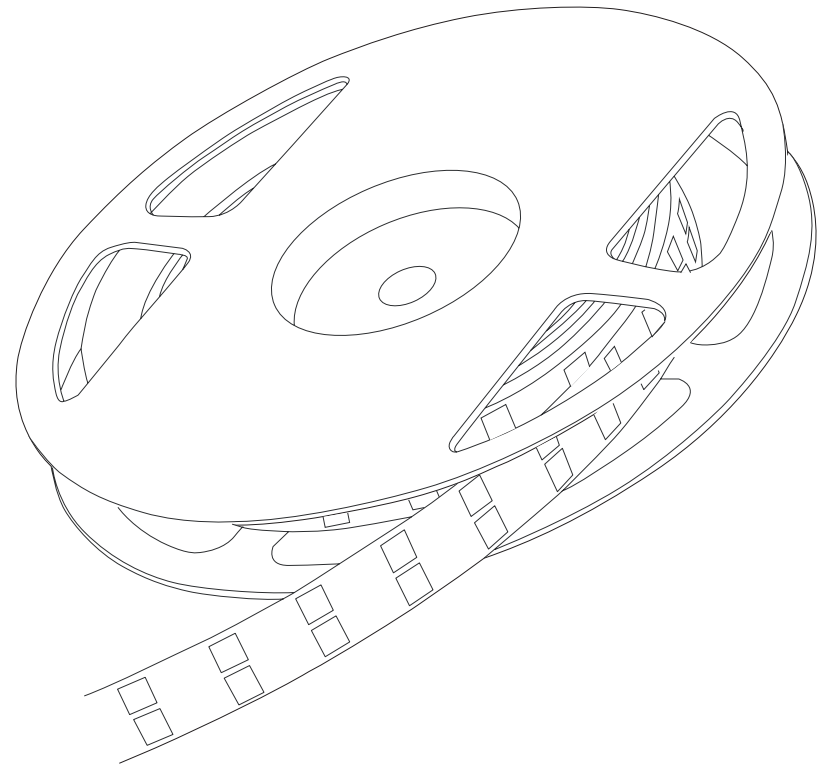

MJ-F2835L160WX-X-HE

Comprehensive Description

Applying to BLIGHT, decorative lighting, LED Strip has the features of long lifetime and small brightness decay.

Various color temperature are available and only ONE BIN is used for each order to keep same color.

Material and technology:

- ◆ LED is packaged with pure gold thread and large chip;
- ◆ Lead-free SMT(RoHS), welding spot is rounded and strong;
- ◆ Double layer PCB to ensure stable electrical property;
- ◆ Authentic 3M adhesive tape with stronger stickiness;
- ◆ A variety of fittings are optional to install easily;
- ◆ Different waterproofing grade: IP65, IP67, IP68 and Nano waterproof;
- ◆ The best silica gel is used to make waterproof;

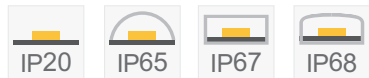

Technical Parameters

Model: MJ-F2835L160WX-X-HE

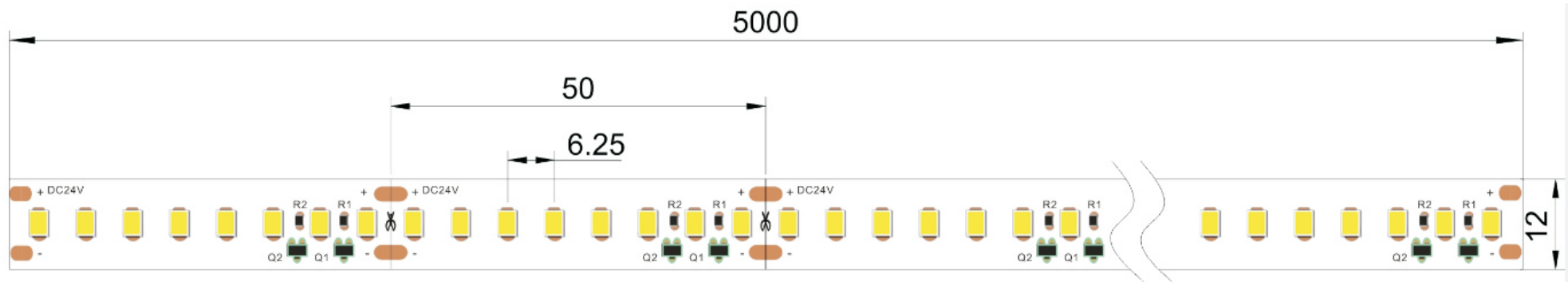

Optical parameters

LED Type	SMD2835
Ra	CRI>80&CRI>90
CCT	2400K/2700K/3000K/4000K/6000K
Emitting Angle	120°
Luminous flux/LED	28-30lm/LED

Electrical parameters

Input Current	0.875A/m
Input Voltage	DC24V
Watt/m	21W/m

Others

Energy Efficiency	A
Warranty	5 years
Operating lifetime	30,000h
Operating temperature	-20°C- +45°C
Operating humidity	40%-70%RH
Waterproof grade	IP20,IP65,IP67,IP68
Dimensions	5000*12mm
LED Qty/m	160LED/m
Min cuttable distance	50mm(8LED)

Test Report

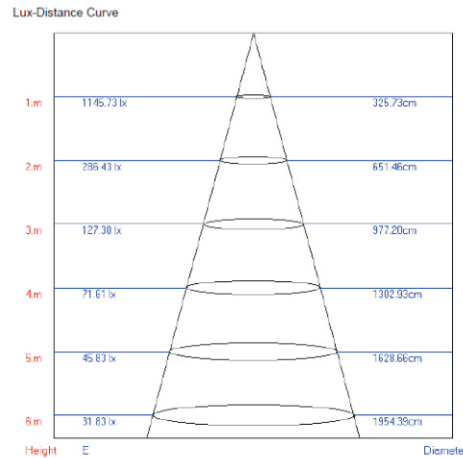
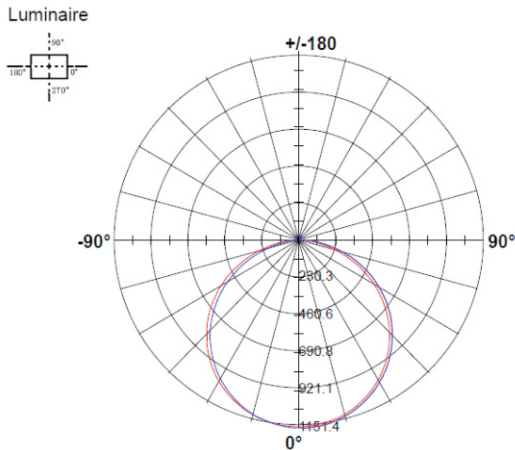
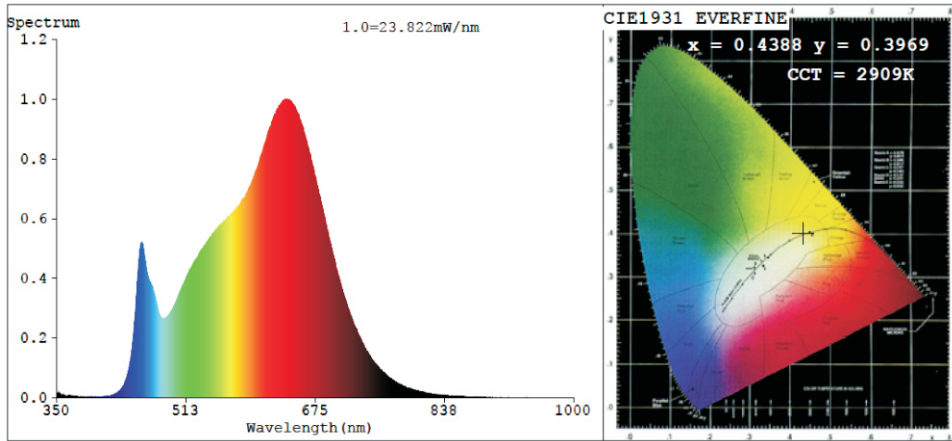

Certifications

Intertek AUTHORIZATION TO MARK

This authorizes the application of the Certification Mark(s) shown below to the models described in the Product(s) Covered section when made in accordance with the conditions set forth in the Certification Agreement and Listing Report. This authorization also applies to multiple later models identified on the correlation page of the Listing Report. This document is the property of Intertek Testing Services and is not transferable. The certification mark(s) may be applied only at the location of the Party Authorized To Apply Mark.

Applicant: Shenzhen Shinesky Optoelectronics Co., LTD
Address: 2F, H1 Building, Hongfa Hi-tech Park, Tangtou, Shiyuan Town, Bao'an District, Shenzhen, Guangdong, China
Contact: Bin Yu
Phone: +86-755-29116235
FAX: +86-755-29116235
Email: mui@szshinesky.com

Manufacturer: Shenzhen Shinesky Optoelectronics Co., LTD
Address: 2F, H1 Building, Hongfa Hi-tech Park, Tangtou, Shiyuan Town, Bao'an District, Shenzhen, Guangdong, China
Contact: Bin Yu
Phone: +86-755-29116235
FAX: +86-755-29116235
Email: mui@szshinesky.com

Party Authorized To Apply Mark: Intertek Testing Services Shanghai

Control Number: 5000956 **Authorized by:** Thomas J. P. O'Connell, Certification Manager

Intertek Testing Services NA Inc.
 645 East Argonne Road, Aliso Viejo, CA 92656
 Telephone: 949.361.8500 or 949.433.5867 Fax: 949.286.9722

Standards: General Requirements for Luminaires - CIEA C22 No 9.8 (Issued: 1996/06/01 Ed. 1 (2011), with Cor. 1: 1997, Cor. 2: 1998)

Product: Low Voltage Fixtures - LED Strip

Model: SH-CY102-2, where "X", "Y" and "Z" is any number, "C" is a letter in the combination of a letter and a number

ATM for Report 153006495NA-001 Page 1 of 1 ATM issued: 21 May 2015

CERTIFICATE of Conformity
 EC Council Directive 2004/108/EC
 Electromagnetic Compatibility

Registration No.: AE 50329836 0001
Report No.: 17055806 001

Holder: Shenzhen Shinesky Optoelectronics Co., LTD
 2F, H1 Building, Hongfa Hi-tech Park, Tangtou, Shiyuan Town, Bao'an District, Shenzhen, City 518108, P.R. China

Product: LED Lamp (LED Strip)

Identification: Type designation: SH-TH0710 ('s', 'y', 'z' are variables, refer to report for details)
 Serial No.: n.a.
 Remark: Refer to test report 17055806 001 for details.

Tested acc. to: EN 60529:2012
 EN 61347:2009

This certificate of conformity is based on an evaluation of a sample of the above mentioned product. Technical Report and documentation are at the License Holder's disposal. This is to certify that the tested sample is in conformity with all provisions of Annex 1 of Council Directive 2004/108/EC. This certificate does not imply assessment of the production of the product and does not permit the use of a TÜV Rheinland mark of conformity. The holder of this certificate is authorized to use this certificate in connection with the EC declaration of conformity according to the a.m. Directive.

Date: 15.01.2015
 TÜV Rheinland LGA Products GmbH · Tillystraße 2 · 90431 Nürnberg
 Dipl.-Ing. Ulf S. C. Steinhilber

CE The CE marking may only be used if all relevant and effective EC Directives are complied with. CE

SGS Test Report No. NTL14101706171041 Date: FEB 18, 2014 Page 1 of 6

SHENZHEN SHINESKY OPTOELECTRONICS CO., LTD
 2F, H1 BLDG, HONGFA HI-TECH PARK, TANGTOU, SHIYUAN TOWN, BAO'AN DISTRICT, SHENZHEN, P.R. CHINA

This report supersedes all the previous documents bearing the test report number 7030107106171041.

The following sample were submitted and identified by you: SH-CY102-2 LED STRIP

Sample Reference Information: SEE ATTACHMENT
Sample Receipt Date: JAN 07, 2014
Further Information Date: FEB 18, 2014
Testing Period: JAN 07, 2014 TO JAN 16, 2014

Test Requested	Conclusion
1. European RoHS Directive 2011/65/EU Annex II (excluding 2002/95/EC) (Electronic specimens) were tested as specified by the applicant. (Refer to test report for details)	PASS

FOR FURTHER DETAILS, PLEASE REFER TO THE FOLLOWING PAGE(S):

Signed for and on behalf of: SHENZHEN SHINESKY OPTOELECTRONICS CO., LTD, Shenzhen Branch-Try Laboratory

Party Signatory, address: Shenzhen Branch-Try Laboratory

SGS Member of the SGS Group (2013)

SGS CERTIFICATE of Conformity

SHENZHEN SHINESKY OPTOELECTRONICS CO., LTD.
 2F, H1 Building, Tangtou Hi-tech Park, Tangtou, Shiyuan Town, Bao'an District, Shenzhen, Guangdong, P.R. China
 United States Code Title 480300191681324

This certificate is valid from 1 March 2017 until 1 March 2020 and covers only the application of the standards mentioned.

Registration date: 08 Dec 2014 Issue 1 Certified since 2 March 2017

ISO 9001:2015

Design and manufacture of LED strip products

For further details, please refer to the following page(s):

SGS Reference Number: SHEN14101706171041
 Reference Number: SHEN14101706171041
 Reference Number: SHEN14101706171041

SGS 9001 0001 000 Page 1 of 1

SGS **UKAS** **9001**

Installation Instructions

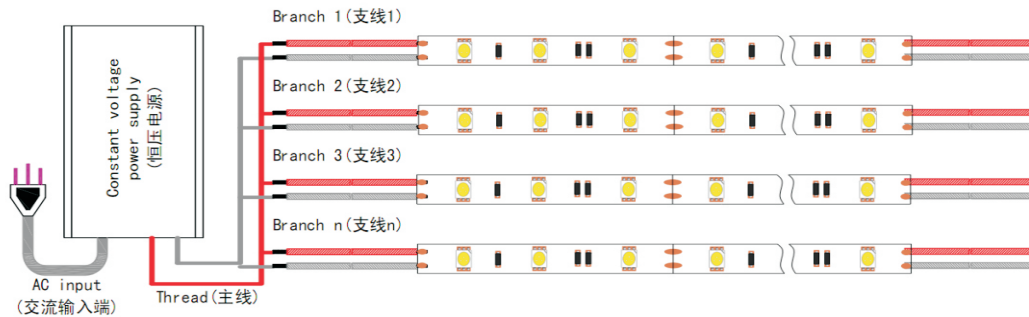

Package

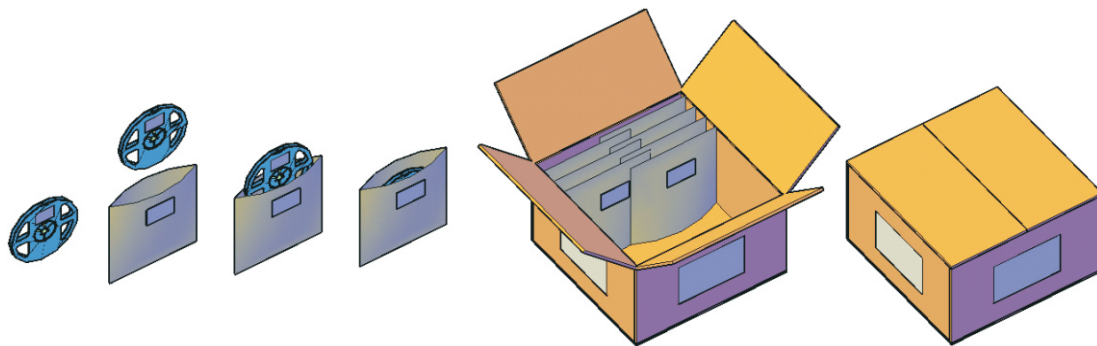

Note:

1. One Aluminum Foil Bag for one roll of LED strip, 5M/roll.
2. All the packaging materials are RoHS standard.
3. Heavy stuff are not allow to be loaded above the packaging box.

⚠ Cautions:

- When install the led strip , please note the installation technique. The led strip can be bent, but not distorted, as shown below:

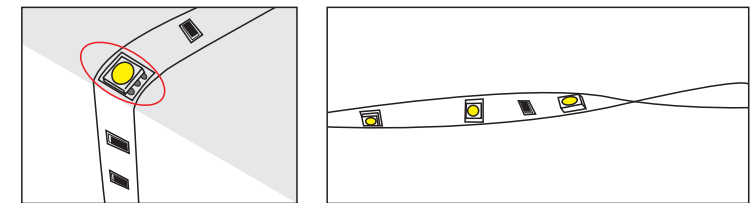
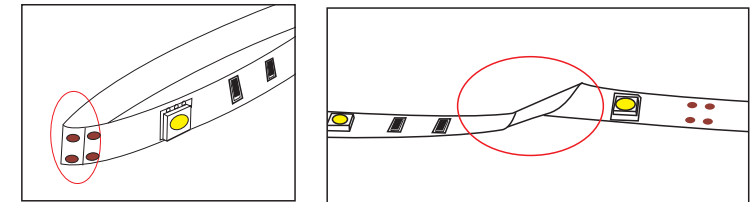

Distortion(Wrong)

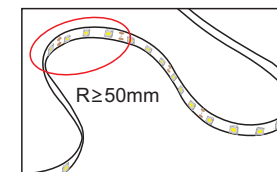

Bend(Right)

- LED strips are low voltage products, you must use the power supply(transformer). Please don't connect the led strip directly to the AC110 or AC220V, otherwise it will burn out the LED strips.
- Clean up the installation surface, it will ensure the reliability of the adhesive.
- The electrical connection process must be operated by a professional person.